



## Models Z7, Z11, Z602WA and Z820WA Impedance head operating guide



## Safety section

The impedance head can be safely operated when the instructions in this manual are carefully followed.

This section summarizes the safety considerations. Reminders, in the form described below, will appear in the detailed instructions to assure operator awareness of these safety considerations.



**WARNING:** This symbol is used in the instruction manual where operator safety must be considered. The instruction manual should be consulted and read carefully.

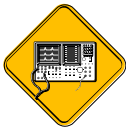

**CAUTION:** This symbol is used when caution is needed to prevent damage to equipment. It is used where careful attention to certain procedures described in the instruction manual is needed. This symbol is also used to emphasize procedures other than normal operating procedures.

## Safety summary

1. Make sure that any shaker power amplifier is properly grounded to a good earth ground.
2. Make sure that any piezoelectric shaker being driven is properly grounded to a good earth ground.
3. Disconnect power cords at their source before connecting or removing any cables.
4. All cables must be connected between the power amplifier, matching network and shaker before electrical power is connected. Inspect for frayed or cut cables prior to operation.
5. Wear hearing protection when driving piezoelectric shakers at high levels and high frequencies.
6. Do not expose this equipment to rain or moisture.
7. Use common sense and avoid haste!



# Contents

- Safety section ..... 2**
- Safety summary ..... 2**
- 1.0 Theory of operation ..... 4**
  - 1.1 Mechanical construction ..... 4
  - 1.2 Electronic principles of operation ..... 4
    - 1.2.1 Charge mode sensors ..... 5
    - 1.2.2 Integrated Electronic Piezoelectric Sensors (IEPE) ..... 6
- 2.0 Product description ..... 6**
  - 2.1 Z7 impedance head (F7 shaker) ..... 6
  - 2.2 Z11 impedance head ..... 6
  - 2.3 Z602WA impedance head ..... 7
  - 2.4 Z820WA impedance head ..... 7
  - 2.5 Mating shaker models and cabling ..... 7
- 3.0 Installation ..... 9**
  - 3.1 Mechanical ..... 9
    - 3.1.1 Z7 impedance head (F7 shaker) ..... 9
    - 3.1.2 Z11 impedance head ..... 9
    - 3.1.3 Z602WA impedance head ..... 9
    - 3.1.4 Z820WA impedance head ..... 10
  - 3.2 Electrical connections ..... 10
    - 3.2.1 Z7 impedance head (F7 shaker) ..... 10
    - 3.2.2 Z11 impedance head ..... 10
    - 3.2.3 Z602WA impedance head ..... 11
    - 3.2.4 Z820WA impedance head ..... 11
- 4.0 Operation ..... 11**
  - 4.1 Troubleshooting ..... 11
  - 4.2 Checking the output from charge-mode impedance heads ..... 12
- 5.0 Maintenance ..... 12**
- 6.0 Warranty ..... 12**



## 1.0 Theory of operation

### 1.1 Mechanical construction

The impedance head is a transducer. It contains two sensing elements. The force sensing element senses the force acting between the shaker input connection and the test item connection while the accelerometer senses the acceleration on the input connecting end. A simplified mechanical diagram is illustrated here.

In this simplified diagram, the shaker is presumed to connect at the "top" of the impedance head. The item being tested is connected to the "bottom" of the impedance head. This simplified diagram uses a single attachment threaded hole at each end for this example. The two sections marked with "F" represent the force sensing element(s). The accelerometer mass attaches to the accelerometer's sensing element, marked with an "A", and is mounted on the shaker input end of the impedance head.

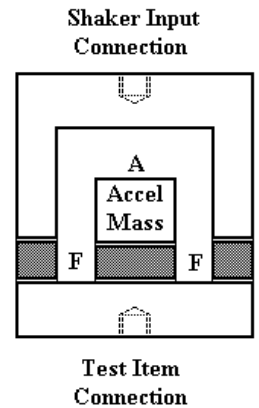

The effective impedance head mass between the force sensing element and the test item connection is referred to as the "mass below the force gauge" in all specifications. The mass below the force gauge is important to modal analysts so that the structural mass can be accommodated in modal analysis calculations.

### 1.2 Electronic principles of operation

All Wilcoxon Sensing Technologies impedance heads operate under the principles of piezoelectric transduction. Transduction is a process where mechanical energy is converted into electrical energy. Piezoelectric transduction takes advantage of the properties of some materials that produce an electric charge when they are subjected to mechanical strain.

The Z11 impedance head, available with the F5B shaker, and the Z7 impedance head, integral to the F7 shaker, are both charge-mode impedance heads. That means the impedance head sensors contain no integrated electronic amplifier. The Z7 and Z11 impedance heads should have an external charge amplifier or charge converter to produce a voltage signal for use by other instrumentation.

The Z602WA and the Z820WA have integrated electronic amplifiers built-in. These amplifiers require powering using a constant-current diode, or similar circuitry. This method of powering a sensor and getting the signal out of the same wire is known as Integrated Electronic Piezo-Electric (IEPE). These types of sensors have a low impedance electrical output signal that is highly immune to electrical interference. They yield good signal levels with low levels of noise pick-up in the circuit.



### 1.2.1 Charge-Mode Sensors

A charge mode piezoelectric sensor, when stressed, generates a high electrostatic charge from the Lead-Zirconate-Titanate (PZT) piezoceramic material. This high impedance charge must be connected using a low noise cable to a special amplifier such as a laboratory charge amplifier or source follower amplifier, sometimes called a charge converter, for measurement purposes.

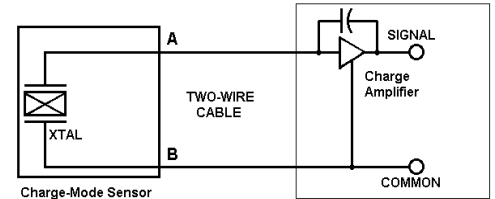

The charge amplifier is essentially an integrating amplifier. It has high input impedance and converts the charge signal to a voltage-mode signal driven by the low impedance of the output amplifier circuit. The primary function of the charge or voltage amplifier is to convert the high impedance charge output to a usable low impedance voltage signal for recording purposes. Laboratory charge amplifiers provide the impedance conversion required, but have drawbacks as they can drift and result in amplifier saturation.

A connection from the sensor directly to a readout device such as an oscilloscope is possible, but not recommended, as the high impedance isolation required cannot usually be maintained easily. However, the data sheet for charge-mode piezoelectric sensors will indicate the open-circuit voltage sensitivity at the end of the standard cable supplied with the sensor. This information is helpful for assistance in any troubleshooting efforts to determine if the sensor is generating an output signal of the approximate amplitude anticipated.

Miniature, in-line charge converter amplifiers are generally used for interfacing between the charge-mode sensors and measurement systems. Charge converter amplifiers are available in varying sensitivities to accommodate a wide range of useful output sensitivities. The charge converter amplifier acts to convert the charge-mode circuit into one like the Integrated Electronic Piezo-Electric (IEPE) sensor uses.

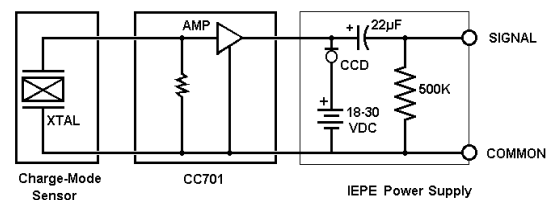

When considering the use of charge-mode systems, remember that the output from the PZT ceramic is a pure electrostatic charge. The internal components of the sensor and the external electrical connector maintain a very high, typically greater than  $10^{12}$  ohm, insulation resistance so that the electrostatic charge generated by the PZT piezoceramic does not become shunted through the resistance and result in a loss of dynamic range. Connectors, cables and charge converters used must also have a very high input insulation resistance to maintain the integrity of the signal. Contaminants such as moisture, dirt, oil, or grease can all contribute to reduced isolation of the signal, resulting in signal drift and erroneous results.

Use of special low noise cable, Wilcoxon types J1 or J3, is required with charge mode sensors to connect them to the charge converter line amplifier (CC701). Typical shielded, twisted pair wire and coaxial cables generate an electrostatic charge between the conductors when the cable is moved. This is referred to as triboelectric noise and cannot be distinguished from the sensor's own electrostatic signal output. Low noise cables have a special lubricant between the dielectric and shield to minimize the triboelectric effect by maintaining the dielectric constant in the cable.





The CC701 requires a constant-current diode for powering. An example of an IEPE power supply is illustrated above. The Wilcoxon P702B, P703B or P704B power supplies can power the transducers in the Z602WA and Z820WA impedance heads. Table 1 in section 2.5 outlines the power supply options for each of the impedance heads.

### 1.2.2 IEPE sensors

IEPE sensors incorporate a built-in junction field effect transistor (JFET) microelectronic amplifier to convert the high impedance charge output into a low impedance voltage signal for recording. IEPE sensors, powered from a constant current source, can operate over long cables without significant signal degradation. This is possible because the output is a voltage-mode signal.

Since the built-in amplifier is a low impedance source, it operates similarly to any low output impedance amplifier. Cable resistance and connection isolation resistance do not generally have any effect on the signal. The low impedance voltage signal is also not affected by triboelectric cable noise or connection contamination.

Wilcoxon P702B, P703B or P704B power supplies can power the transducers in the Z602WA and Z820WA impedance heads. Table 1 in section 2.5 outlines the power supply options for each of the impedance heads.

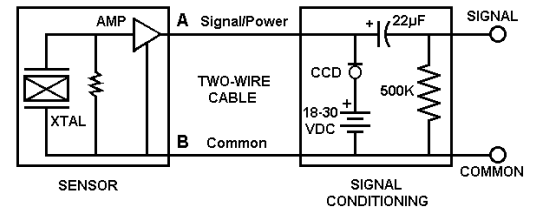

## 2.0 Product description

### 2.1 Z7 Impedance head

The Z7 impedance head is an integral part of the F7 piezoelectric shaker. It contains a piezoelectric accelerometer and a piezoelectric force gauge. The output from these high impedance, charge-mode sensors is from two 10-32 coaxial (Microdot®) connector jacks on the periphery of the transducer. They are marked “A” for acceleration and “F” for force. The Z7 has a mass below the force gauge of approximately 0.7 ounces (20 grams).

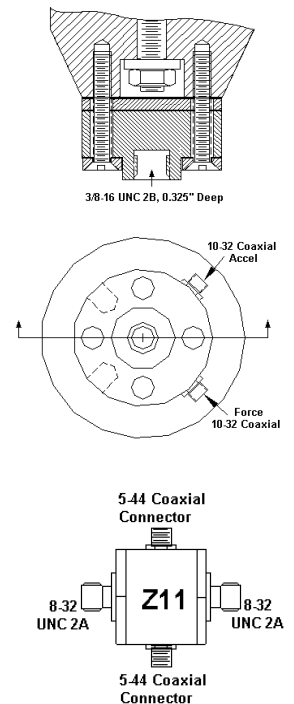

### 2.2 Z11 impedance head

The Z11 impedance head is a cylindrical structure containing a piezoelectric force gauge and a piezoelectric accelerometer. It is designed to be driven by the F5B electromagnetic shaker. The Z11 features a charge-mode accelerometer with a wide frequency range and a high-sensitivity charge-mode force gauge. The output from these sensors is through the 5-44 coaxial (Iprechaun®) connectors located on either side of the impedance head. They are marked “A” for acceleration and “F” for force.

This impedance head has a diameter of 1/4 inch at the surface contacting the test structure thereby preventing excess stiffening of the impedance head. In addition, the Z11 has a mass below the force gauge of only 0.04 ounces (1 gram) making it



possible to make measurements on relatively light structures, such as airframes, models, light machinery, etc.

### 2.3 Z602WA impedance head

The Z602WA impedance head is a cylindrical structure containing a piezoelectric force gauge and a piezoelectric accelerometer. It is designed to fit inside and be driven by the F3 electromagnetic shaker. The high impedance charge output signals from the piezoelectric accelerometer and the force gauge are internally amplified using a PiezoFET® low noise charge amplifier. This amplifier produces low output impedance signals suitable for driving long cable lengths and requires a constant current DC supply, such as the Wilcoxon P703B or P704B, for power.

Because the surface in contact with the structure under test is only 0.56 inches in diameter, this small size prevents excessive stiffening of the structure when the instrument is attached. The Z602WA has a mass below the force gauge of 0.7 ounces (20 grams).

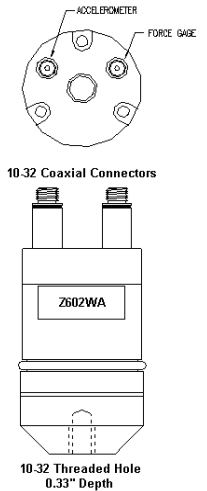

### 2.4 Z820WA impedance head

The Z820WA impedance head is a cylindrical aluminum housing containing a piezoelectric force gauge and a piezoelectric accelerometer. It is designed to be concentric with, and driven by, the F4 or F10 electromagnetic shaker. In the Model Z820WA, the high impedance charge output signals from the piezoelectric accelerometer and the force gauge are internally amplified. PiezoFET® low noise charge amplifiers produce low output impedance signals suitable for driving long cables. PiezoFET® amplifiers require a constant current DC supply. The Z820WA has a mass below the force gauge of 4.9 ounces (140 grams).

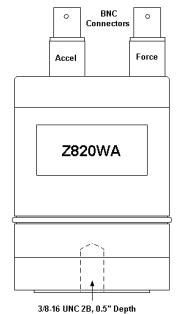

### 2.5 Mating shaker models and cabling

Below is a table outlining the impedance heads available for each type of Wilcoxon Sensing Technologies vibration excitation shaker. The F4 and F10 shakers have a center-mounting position where either an impedance head or the F7 piezoelectric shaker can be installed. If the Z820WA impedance head is installed, then IEPE powering signal conditioning must be used with the impedance head. If the F7 shaker is installed, then a charge converter must also be used in order to convert the charge-mode output of the Z7 impedance head to the low-impedance voltage-mode type compatible with IEPE electronics.



Table 1 – Shakers and impedance heads

Shaker model	Impedance head/ shaker options	Signal conditioning options	Notes
F3	Z602WA	(2) P702B or P703B or (2) P704B	Constant-current IEPE powering electronics
F4	Z820WA	(2) P702B or P703B or (2) P704B	Constant-current IEPE powering electronics
F4	F7 shaker	See Z7 requirements	See Z7 requirement
F5B	Z11	(2) CC701 or (2) CC701HT and (2) P702B or P703B or (2) P704B	Charge-mode impedance head, needs CC701/CC701HT and constant-current IEPE powering electronics
F7	Z7 is built-in	(2) CC701 or (2) CC701HT and (2) P702B or P703B or (2) P704B	Charge-mode impedance head, needs CC701/CC701HT and constant-current IEPE powering electronics
F10	F7 shaker	See Z7 requirements	See Z7 requirements
F10	Z820WA	(2) P702B or P703B or (2) P704B	Constant-current IEPE powering electronics

Table 2 – Cables included with impedance heads

Impedance head model	Impedance head connector (model)	Cable to CC701 series	Cable to power supply, all are BNC input (P702B, P703B, P704B or PR710A)
Z7	10-32 Microdot® (1)	R1-1-J1-6	n/a
Z11	5-44 Leprechaun® (3A)	R1-3A-J2-6	n/a
Z602WA	10-32 Microdot® (1)	n/a	R1-2-J93-10
Z820WA	BNC (2)	n/a	R2-2-J5-10





### 3.0 Installation

#### 3.1 Mechanical

The boss on the face of the impedance head should rest flush against the structure under test. This area varies with each impedance head. Proper results for mechanical impedance measurements can only be obtained when this mating surface is used. The impedance heads are not designed to produce consistent results if only the thread of the mating bolt is used for attachment.

##### 3.1.1 Z7 impedance head (F7 shaker)

The F7 shaker with its integral Z7 impedance head mounts to a structure using a 3/8-16 stud. The face of the Z7 impedance head on the F7 has a raised boss of 0.625 inch diameter. To insure optimum frequency performance, this boss should rest flush against the structure under test.

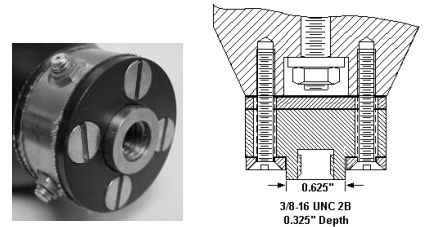

The shaker and 3/8-16 stud should be torqued against the test structure with 120 inch-pounds of torque. A small amount of light grease or heavy oil should be used around the face of the boss to assist in mechanical coupling for the best high frequency vibration energy transfer between the Z7 and the structure under test.

##### 3.1.2 Z11 impedance head

The Z11 has 8-32 integral threaded studs at each end of the impedance head. At the base of the thread is a machined flat surface (boss) of 0.275 inch diameter on the end marked "F" that should rest firmly against the structure under test. The end marked "A" should be connected to the shaker.

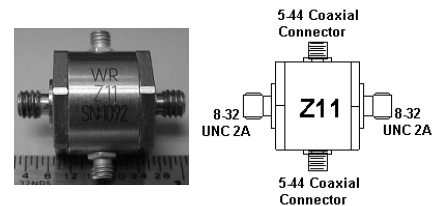

The 8-32 stud of the Z11 should be torqued against the test structure and the F5B shaker with 10 inch-pounds of torque using the hex flats at each end of the impedance head. A small amount of light grease or heavy oil should be used around the face of the boss to assist in mechanical coupling for the best high frequency vibration energy transfer between the Z11 and the structure under test.

##### 3.1.3 Z602WA impedance head

The face of the Z602WA has a 10-32 threaded hole for use in attaching the impedance head to the structure under test. The SF1 mounting stud supplied with the Z602WA is a 10-32 to 10-32 adapter. One end should be threaded into the face of the Z602WA and the other end used to screw into the structure. To obtain the best frequency response data the structure should have a flat surface machined to mate with the Z602WA. The outer diameter of the impedance head machined surface is 0.563 inches.

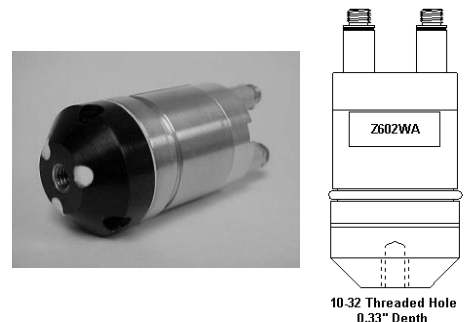



A small amount of light grease or heavy oil should be used around the face of the Z602WA to assist in mechanical coupling for the best high frequency vibration energy transfer between the Z602WA and the structure under test. A torque of 12 inch-pounds should be used for each end of the SF1.

### 3.1.4 Z820WA impedance head

The face of the Z820WA has a 10-32 threaded hole for use in attaching the impedance head to the structure under test. The SF7 mounting stud supplied with the Z820WA is a 3/8-16 to 3/8-16 adapter. One end should be threaded into the face of the Z820WA and the other end used to screw into the structure. To obtain the best frequency response data the structure should have a flat surface machined to mate with the Z820WA. The outer diameter of the impedance head machined surface is 1.625 inches.

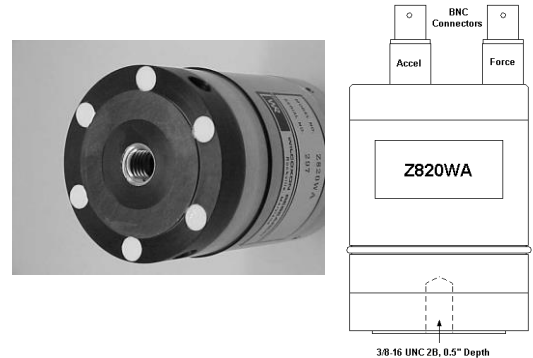

A small amount of light grease or heavy oil should be used around the face of the Z820WA to assist in mechanical coupling for the best high frequency vibration energy transfer between the Z820WA and the structure under test. A torque of 120 inch-pounds should be used for each end of the SF7.

## 3.2 Electrical connections

The Z7 and Z11 are charge-mode sensors. They require the use of either charge amplifiers or charge converters. Wilcoxon has CC701 and CC701HT charge converters as options that can be used to condition the output from the Z7 and Z11 for use as described in section 1.2 of this manual. Table 1 in section 2.5 of this manual outlines the instrumentation options for the impedance heads.

The Z602WA and Z820WA are IEPE type sensors. They require powering as described in section 1.2.2.

### 3.2.1 Z7 impedance head

The Z7 force and acceleration connections are via two 10-32 coaxial connectors on the side of the Z7 impedance head. The connectors are located 90 degrees apart and are labeled "A" for the acceleration output and "F" for the force output.

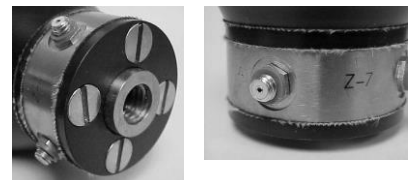

### 3.2.2 Z11 impedance head

The Z11 force and acceleration connections are via two 5-44 coaxial connectors on the side of the Z11 impedance head. The connectors are located 180 degrees apart and are labeled "A" for the acceleration output and "F" for the force output. There is an arrow next to each 5-44 coaxial connector that points to the end of the Z11 on which that sensor is mounted and also refers to the direction of excitation that will produce a positive output signal.





### 3.2.3 Z602WA impedance head

When the Z602WA impedance head is mounted in the F3 shaker, the electrical connectors will project through the back end of the F3. The F3 case is engraved with the channel identifications of the sensors. The connectors are labeled "A" for the acceleration output and "F" for the force output.



### 3.2.4 Z820WA impedance head

When the Z820WA impedance head is mounted in the F4 or F10 shaker, the electrical connectors will project through the back end of the F4 or F10 shaker. The F4 or F10 shaker case is engraved with the channel identifications of the sensors. The connectors are labeled "A" for the acceleration output and "F" for the force output.



## 4.0 Operation

Once all the connections have been verified, turn on the power to the instrumentation. The impedance head will produce signals proportional to the force and acceleration at the driving point of the structure. It is important to note that the force and the acceleration will not always maintain the same relative levels. Since the mechanical impedance of a structure varies with frequency, the ratio of the force and acceleration will also vary with frequency.

### 4.1 Troubleshooting

If there is no force or acceleration output from the impedance head and the shaker is producing vibration, reduce the signal generating system output signal to its minimum and turn off all power to the shaker power amplifier. Check all instrumentation components, check all system fuses, and check all cabling before re-applying power.

**Note:** Time can be saved by checking the connectivity of cables before performing other system checks.

Cables should all be checked for proper connection and conductor conductivity. Using an Ohmmeter, verify that cables are connected from end-to-end and that all conductors are isolated from each other. In other words, verify that connections to connector pins and shells do connect to each other and that there are no shorts in cables.

With the IEPE power supplies supplying power to the Z602WA or Z820WA, check the bias output voltages (BOV) of the force and acceleration transducers. The BOV measured should be between 7 Volts and 14 Volts for either impedance head. The Z7 and Z11 do not have a BOV out of the impedance head, however the CC701 should have a BOV between 7 Volts and 14 Volts.

For information about BOV troubleshooting, refer to Wilcoxon's Technical Note 14, Troubleshooting Industrial Accelerometer Installations.



## 4.2 Checking the output from charge-mode impedance heads

Disconnect the cable from the impedance head at the input to the CC701. Connect it to an oscilloscope. While applying a mild vibratory input to the impedance head, verify that there is a commensurate voltage signal developed from the impedance head, as measured by the oscilloscope.

If there is no signal, re-check all cable integrity and measure again. If there appears to be proper signal output, re-connect the cable to the CC701. Verify proper BOV out of the CC701. Again, while applying a mild vibratory input to the impedance head, verify that there is a commensurate voltage signal out of the CC701, as measured by the oscilloscope.

Contact Wilcoxon Sensing Technologies for additional assistance in conducting troubleshooting if this fails to isolate the problem.

## 5.0 Maintenance

There is no maintenance that can be performed by the user of the impedance head. If it is suspected that the impedance head is not operating properly, please contact Wilcoxon Sensing Technologies customer service.

## 6.0 Warranty

### 6.1 Technical assistance

For technical assistance, please contact Wilcoxon Sensing Technologies customer service at 301-330-8811, or email [info@wilcoxon.com](mailto:info@wilcoxon.com).

### 6.2 Customer service

To obtain a return goods authorization number, please contact customer service at 301-330-8811 or email [info@wilcoxon.com](mailto:info@wilcoxon.com).